

# UTT-205 IP Smart VoIP Phone User Manual



---

Ultrative HK CO., LTD

[www.ultrative.com](http://www.ultrative.com)

## INDEX

INDEX .....	2
1. Getting Started .....	4
About.....	4
Feature Highlights .....	4
2. Set up the Phone .....	4
3. Phone User Interface.....	6
3.1 Hardware Component Instructions.....	6
3.2 Phone Screen Display Features .....	8
3.3 Basic Network Settings.....	9
3.4 SIP Account Settings.....	10
3.5 Basic Features.....	11
3.5.1 Making a Call .....	11
3.5.2 Anonymous Call.....	11
3.5.3 Redial.....	12
3.5.4 Call Log .....	12
3.5.5 Making Calls to Contact.....	12
3.5.6 Multi-lines to Answer the Call .....	13
3.5.7 Auto-Answer .....	13
3.5.8 Ending a Call .....	13
3.5.9 Using Hold and Recover (Switch Calling Line) .....	14
3.5.10 Transferring Calls .....	14
3.5.11 Using Mute .....	15
3.5.12 Do Not Disturb .....	15
3.5.13 3-way Conference.....	16
3.5.14 Voice Mail.....	16
3.6 Advanced Settings .....	17
3.6.1 Using the phone book .....	17
3.6.2 Using Call Logs .....	20
3.6.3 Peer-to-Peer .....	20
3.7 Keypad Setting.....	20
3.7.1 Language Setting .....	21
3.7.2 Message .....	21
3.7.3 Time & Date .....	21
3.7.4 Ring Tone and Volume Setting .....	22
3.7.5 Searching Phone Book.....	22
3.7.6 Cannot Set the Features with Keypad .....	23
4. WEB User Interface .....	23
Main Interface-Phone Status .....	23
4.1 Net Work .....	24
4.1.1 LAN Port .....	24
4.1.2 PC Port.....	26

4.1.3 Advanced.....	27
5 SIP Account.....	28
5.1 Basic.....	28
5.2 Call.....	29
5.3 Security.....	30
6 Phone Setting.....	31
6.1 Basic.....	31
6.1.1 Time Settings.....	32
6.1.2 Call.....	33
6.1.3 VoIP Call Forward.....	34
6.1.4 QoS.....	35
6.2 Advanced.....	35
6.2.0 Audio.....	35
6.3 Line Keys.....	37
6.4 Function Keys.....	38
6.5 Soft Key.....	38
6.6 Dial Plan.....	39
6.7 IP Strategy.....	40
7 Phone Book.....	40
7.1 Group.....	40
7.2 Contact.....	41
7.3 LDAP.....	41
7.4 Ban List.....	42
8 Phone Maintenance.....	43
8.1 Basic.....	43
8.1.1 HTTP Upgrade.....	43
8.1.2 FTP Upgrade.....	44
8.1.3 TFTP Upgrade.....	45
8.1.4 Default Setting.....	46
8.1.5 Reboot.....	46
8.2 Advanced.....	47
8.2.1 Log.....	47
8.2.2 Auto Provision.....	47
9 Password.....	49
10 WEB Other Settings or Information - Appendix.....	49
10.1 WEB User.....	49
10.2 Multi-Language.....	49
10.3 Note Tips.....	50

# 1. Getting Started

## About

ULTRATIVE UTT-205 is a compact office IP phone with rich features. It has 128\*64 HD graphic LCD up to 4-line display; it also has HD Sound Quality, unique art design, demountable bracket to provide multi-angle, 4 soft keys, and friendly user interface to satisfy users's communication needs.

## Feature Highlights

- a) **Multi-Language**  
The LCD display supports Multi-Language.
- b) **HD Voice**  
Special voice processing technology, high-fidelity voice quality, HD encoding, HD Handset, ensure clear, realistic smooth communication.
- c) **Senior Calling Ability**  
2 lines with double color (GREEN & RED) LEDs, Synchronously control or manage 2 calls, Call queue, Switch between lines. Multi-parties conference, call transfer.
- d) **All kinds of Phone Book**  
It supports XML Personal Phone Book\LDAP\Enterprise Phone Book etc. This feature satisfies customer's phone book requirements.
- e) **Support HTTP\TFTP\FTP\Auto-Provision.**
- f) **Support POE (Remark: UTT-205-P) and Power Adapter.**
- g) **2-angle adjustable bracket.**
- h) **Support 9 programmable keys.**

## 2. Set up the Phone

### a) Packing List:

Check the packing list before installation, if you find anything missing, contact your system administrator.

- 1\*UTT-205 IP Phone
- 1\*Handset
- 1\* Handset Cord
- 1\*Ethernet Cable

- 1\*Phone Bracket
- 1\*Quick Setup Guide

#### b) Phone Installation:

This section introduces how to install the phone with the components in the packing list:

- Attach the Bracket
- Connect the Handset and optional Headset
- Connect the Network and Power

#### Attach the Bracket

Please follow as below pictures to attach the bracket.

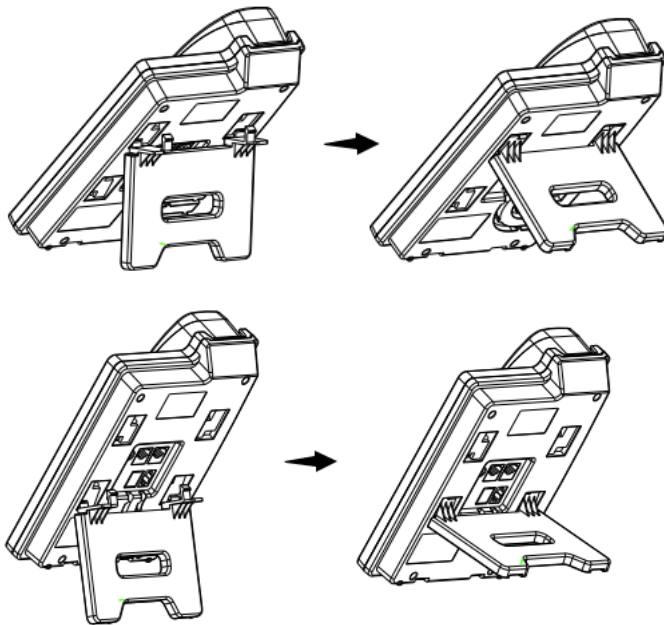

#### Connect the Handset and optional Headset

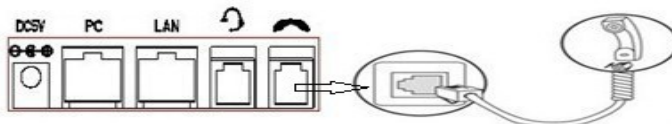

NOTE: Headset port & PSTN port is option. The Back light of LCD also is option.

#### Connect the Network and Power

You have two options for power supply. Your system administrator will advise you which one to use.

- AC power adapter
- POE(Power over Ethernet) IEEE802.3af

**NOTES:** Please make sure your phone support POE feature. You can check the label on the back of the phone, for example "Model: UTT-205-PN Rev:2.1.0", the P means it support POE feature.

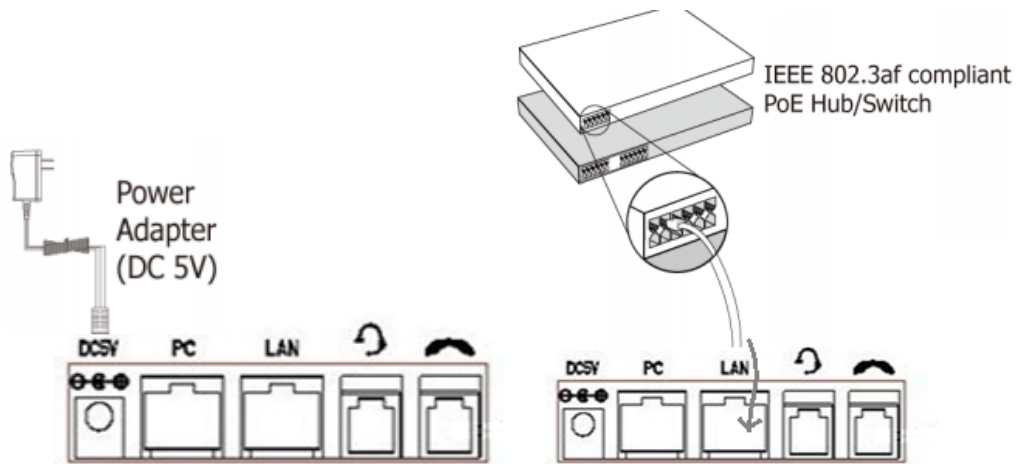

Note: If POE works, the phone doesn't need to connect to the AC power adapter. Make sure the Ethernet cable and switch/hub is POE compliant.

## 3. Phone User Interface

### 3.1 Hardware Component Instructions

The main hardware components of the UTT-205 IP Phone are the LCD screen and the keypad.

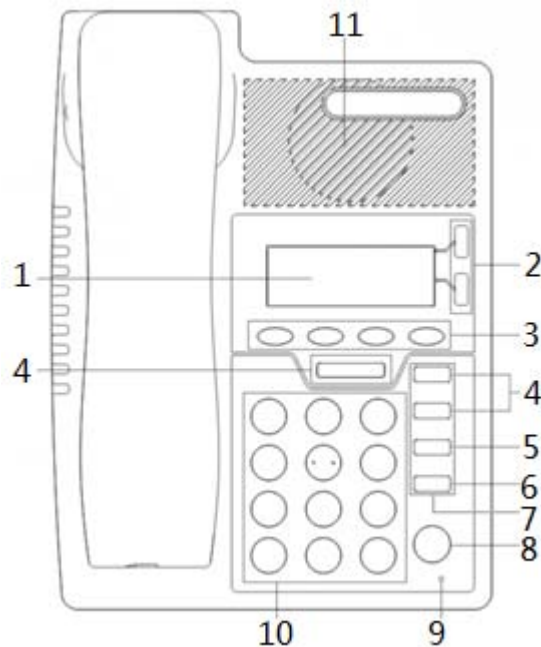

Hardware component instructions of the UTT-205 IP Phone are:

	ITEM	DESCRIPTION
1	LCD Screen	<p>Displayed information about calls, messages, soft keys, time, date and other relevant data:</p> <ul style="list-style-type: none"> <li>• Call information — caller ID, call duration</li> <li>• Icons (e.g. <b>DND</b>)</li> <li>• Missed calls or second incoming caller's information</li> <li>• Time and date</li> </ul>
2	Line Key	<p>Red, flashing: Incoming call  Red, steady: Pick up but not on communication  Green, steady: On communication  Green, flashing: On hold  Light off: Idle  NOTE: Light yellow steady: Under the idle status, the light will on when: Missed Call, Transfer, DND, Message, Mute, SIP-Unregistered.</p>
3	Soft Key	Labels automatically to identity their context-sensitive features
4	Navigation Key&Volume Key	<p>In the idle status, press UP or DOWN key can check the call log:  UP: Open the "All CONTACT LOG", DOWN: Open the "MISSED CALL", RIGHT and LEFT can check other list, like "RECEIVED CALL\DAIL CALL".  In the idle or talking status, press RIGHT or LEFT key can adjust the volume.</p>
5	Mute & C Key	<p>Cancels actions or rejects an incoming call, and the other feature:  In the idle: Open the "Phone Status".  Diagnosis: Press and hold 3 second to open "Hardware Diagnosis".  MUTE: "MUTE" feature is enabled if you press it while the conversation making on the phone.</p>
6	Redial Key	Dial the latest number.
7	Programmable Key	<p>In the idle status, press and hold 3s will enter programmable function, the default password is empty:  Line 1 &amp; 2: press and hold can quickly enter account setting. If you want set it to another function, you need to login into website to change it.  Navigation key UP &amp; DOWN, Redial key press and hold can quickly enter programmable key setting function, they can change to Redial\DND\Personal Phonebook\Enterprise Phonebook\LDAP \Directory\Speed Dial\Call History\Received Calls\Dialed Calls\Main Menu\New Message\Forwarded Calls\View Status\Enable/Disable SIP Account\Default.  NOTE: MUTE&amp;C key isn't support programmable function.</p>
8	Speaker Key	Toggles the hands-free speaker phone mode. Press and hold can change to headset mode
9	MIC	High sensitive pickup Mic.
10	Keypad	Provides the digits, letters and special characters in context-sensitive applications.

11	Speaker	HD speaker.
----	---------	-------------



### 3.2 Phone Screen Display Features

If the phone has successfully started up and after using, the idle LCD display will show information as below:



	ITEM	DESCRIPTION
1	TIME & DATE	TIME & DATE display in the middle of the screen.
2	Auto-Answer icon	Enable this feature, it will display "AA" at the top right corner.
3	Missed Call	Missed Call under the TIME in the middle of screen
4	Line Status	There are four status as below: a. :Disconnect the network b. :Account failed to register c. :Account successfully registered d. :Account successfully registered and DND feature is enabled. The DND icon also will display at the top right corner.
5	Soft Key Area	Labels automatically to identity their context-sensitive features
6	Screen Top Icon	The Screen Top Icon from left to right is: : Handset Hand on status :Speaker Hand on status :Headset Hand on status :Call MUTE :Missed Call :Call Forward :Text Message



		 :Keypad Lock  :Network is unavailable
--	--	---

### 3.3 Basic Network Settings

The phone supports Three Modes of Network Setting. Include PPPoE\Static IP\DHCP.

#### DHCP Setting

Feature	Operating Steps
DHCP	Press <b>MENU&gt; System Settings&gt; Advanced Settings&gt; Password</b> (Default is Empty)> <b>Network&gt; LAN Port</b> <ul style="list-style-type: none"> <li>● Press <b>LAN Port</b> to login in to the menu</li> <li>● Select "<b>DHCP</b>" mode</li> <li>● Press "<b>Enter</b>" key</li> <li>● Set the <b>DNS\web port\telnet port</b></li> <li>● Press "<b>Save</b>" key to make it work</li> <li>● Tips "<b>Network is changed, press OK reboot</b> "</li> </ul>

#### Static IP Setting

Feature	Operating Steps
Static IP	Press <b>MENU&gt; System Settings&gt; Advanced Settings&gt; Password</b> (Default is Empty)> <b>Network&gt; LAN Port</b> <ul style="list-style-type: none"> <li>● Press <b>LAN Port</b> to login in to the menu</li> <li>● Select "<b>Static</b>" mode</li> <li>● Press "<b>Enter</b>" key</li> <li>● Set the <b>IP\Mask\GW\DNS\web port\telnet port</b></li> <li>● Press "<b>Save</b>" key to make it work</li> <li>● Tips "<b>Network is changed, press OK reboot</b> "</li> </ul>

#### PPPoE Setting

Feature	Operating Steps
PPPoE	Press <b>MENU&gt; System Settings&gt; Advanced Settings&gt; Password</b> (Default is Empty)> <b>Network&gt; LAN Port</b> <ul style="list-style-type: none"> <li>● Press <b>LAN Port</b> to login in to the menu</li> <li>● Select "<b>PPPoE</b>" mode</li> <li>● Press "<b>Enter</b>" key</li> <li>● Set the <b>User Name&gt;Password\web port\telnet port</b></li> <li>● Press "<b>Save</b>" key to make it work</li> <li>● Tips "<b>Network is changed, press OK reboot</b> "</li> </ul>

### 3.4 SIP Account Settings

UTT-205 IP phone makes calls based on sip accounts, It can support Single account or Multi-account, Each account can be configured to the different SIP server.

If you want to...	Then...
Create an SIP account	<p>--1) Select "System setting" &gt; "Advanced setting";</p> <p>--2) Enter the password required (The default is empty) ;</p> <p>--3) Select "SIP" &gt; "Account sip";</p> <p>--4) Select one of the account you want to setting, you can configure the following parameters</p> <ul style="list-style-type: none"> <li>-<b>Enable account*</b>: Select Enable</li> <li>-<b>Number of lines</b>: Default is 2</li> <li>-<b>Description</b>: description of this account</li> <li>-<b>Display Name</b>: The name displayed on the screen</li> <li>-<b>Authentication user</b>: the Authenticated users are matched with the SIP server.(The default With the same account)</li> <li>-<b>Account*</b>: the account matches with the SIP server.(extension number)</li> <li>-<b>User pass word*</b>: the user password matches with the SIP server</li> <li>-<b>SIP Server*</b>: The primary SIP server, all calls through this server</li> <li>-<b>Out Bound Server</b>: The out bound SIP server</li> <li>-<b>STUN Type</b>: Enable/Disable STUN feature</li> <li>-<b>STUN</b>: Input STUN URL</li> <li>-<b>Auto Answer</b>: Enable/Disable this account auto answer feature</li> </ul> <p>* <b>Note</b>: When you finish the setting, you can press Save to make it work, and then you can see the status icon in the LCD idle. </p> <p>The parameters with the * mark must be set.</p>
Disable sip account	<p>--1) Select "System setting" &gt; "Advanced setting";</p> <p>--2) Enter the password required (The default is empty) ;</p> <p>--3) Select "SIP" &gt; "Account sip";</p>

	--4) Select "Enable account" > "Disable"; --5) Select "Save" to saves settings
--	---

### 3.5 Basic Features

#### 3.5.1 Making a Call

Here are some easy ways to place a call on ULTRATIVE IP Phone:

If you want to...	Then...	
Place a call using the handset	Pick up the handset	--1) You can hear dial tone; --2) Enter a number; --3) Press # button (default), -or wait 5s (default), then it send the number automatically.
Place a call using a speakerphone	Press <b>Speaker</b> button	
Place a call using a headset	Put on your headset, Press and hold the speaker button to active <b>Headset</b> feature, and then do as using speakerphone	

#### 3.5.2 Anonymous Call

You can use anonymous call feature to block the identity and phone number from showing up to the called party when you call someone. E.g, you want to call to consult some of the services, but you don't want to be harassed.

Enable Anonymous Call	Press MENU> Function Setting> Anonymous
	--Press <b>Enter</b> button , -You can select which Account want to use, enable/disable this feature and enable/disable reject anonymous

### 3.5.3 Redial

To redial the last placed call from your phone

Redial	--Press <b>REDIAL</b> button to dial the last number  -or press <b>Navigation button-Left</b> > "Dialed number", select a number, and press <b>Dial</b>
--------	---

### 3.5.4 Call Log



Dial from a call log	--1) Press <b>MENU</b> button > "Call history", you can select "All Calls", "Missed calls", "Received calls" and "Dialed numbers",  - or press <b>Navigation UP/DOWN button</b> (in idle status) > select "All Calls"(up) "Missed calls"(down), <b>left</b> and <b>right</b> can select "Dialed numbers" or "Received calls"  --2) Then press <b>Dial</b> button.  <b>NOTE: You also can press the "log" to login this menu when in the idle.</b>
----------------------	---

### 3.5.5 Making Calls to Contact

You can also dial a contact from the Personal Phone Book.

Placing Calls to Contacts	--1) Press <b>MENU</b> button > "Phone Book", you can select "Personal Phone Book", "Enterprise Phone Book", "LDAP" and "Black List",  - or press <b>Navigation UP/DOWN button</b> (in idle status) > select the desired contact.  --2) Then press <b>Dial</b> button.  <b>NOTE: You also can press the "DIR" to login this menu when in the idle.</b>
---------------------------	--

### 3.5.6 Multi-lines to Answer the Call

Multi-lines to Answer the Call	<p>--1) Another <b>Line</b> button is Red  and flashing, Light strip is Red and flashing;</p> <p>--2) Press the flashing  <b>Line</b> button to answer (at this time, the original call will be hold.)</p>
--------------------------------	--

### 3.5.7 Auto-Answer

You can set the phone and let it auto-answer the coming call.

Auto-Answer the Coming Call	<p>--1) Enable the Auto-Answer feature.</p> <p>--2) Auto-Answer mode you can set in the MENU&gt;Function Setting&gt; Auto Answer &gt;Device</p> <ul style="list-style-type: none"> <li>● Speaker</li> <li>● Handset</li> <li>● Headset</li> </ul> <p>When you use the Handset mode, at this time you need to hands up the handset and then it can work at this status.</p> <p>--3)Filter Groups</p> <p>Auto-answer the coming call in this special groups.</p>
-----------------------------	--

### 3.5.8 Ending a Call

To end a call, hang up. Here are some more details. NOTE: Press and hold the speaker key can change to Handset feature.

Hang up while using the Handset	<p>--Return the handset to its cradle, -or press <b>End</b></p>
Hang up while using the	<p>--Press <b>Speaker</b> button,</p>

Speakerphone	-or press <b>Line</b> button for the appropriate line, -or press <b>End</b>
Hang up while using the Headset	--Press <b>Handset</b> button, (Do not keep the headset mode) , -or press <b>End</b> (keep the headset mode)
Hang up one call, but preserve another call on the other line	--Press <b>End</b> , -or refer to the above three methods

### 3.5.9 Using Hold and Recover (Switch Calling Line)

You can hold and resume calls. You can take a call in one line at anytime, and the other lines would be hold. As a result of that, you can switch different calling line on our phone. Note: If the phone isn't have the hold button, Please using the soft key.

If you want to...	Then...
Put a call on hold	--Press <b>HOLD</b> button, -or press soft key <b>Hold</b>
Hold a line and switch to another line	Press another <b>Line</b> button for the appropriate line
Resume a call on current line	--Press <b>Line</b> button,
Release a call on different line	Select the line want to release hold, press the line, so recovery;

#### NOTES

- Engaging the Hold feature typically generates music or a beeping tone.
- A held call is indicated by the Yellow-green and flashing Line button or Hold in the LCD.

### 3.5.10 Transferring Calls

Transfer redirects a connected call. The target is the number to which you want to transfer the call.

Talk to the transfer recipient before	--1) Press <b>TRANSFER</b> button or press XFER; --2) Enter number;
---------------------------------------	--

transferring a call (consult transfer)	--3) press “#” (default) , -or press <b>Send</b> then transfer the call, -or wait five seconds(default)then transfer the call
Transferred to idle lines or other numbers without talking to the transfer recipient (Blind transfer)	--1) Press <b>TRANSFER</b> button or XFER; --2) Press <b>Blind</b> ; --3) Enter number; --4) Press “#” (default) -or press <b>Send</b> , then transfer the call; -or wait five seconds(default)then transfer the call
Blind transfer to the held line	--1) Press <b>TRANSFER</b> button or press XFER; --2) Press the <b>Line</b> button of held line

### 3.5.11 Using Mute

With Mute enabled, you can hear other parties on a call but they cannot hear you. You can use mute in conjunction with the handset, speakerphone, or a headset.

Toggle Mute on	Press <b>C</b> button, then the screen top and left will have a MUTE icon 
Toggle Mute off	Press <b>C</b> button again, then the button light off

### 3.5.12 Do Not Disturb

You can use the Do Not Disturb(DND) feature to block incoming calls on your phone with a busy tone (Can also be set to their voice mail or other extension numbers, etc.).

Enable global DND	--1) Press <b>DND</b> ;  --2) All enabled line on the phone would changes to  status. and the icon is <b>DND</b> .
Enable DND on a single line	Press <b>MENU</b> button > “Function setting” > “DND” > (select line) “Enable”
Disable DND	--Global DND enabled, press <b>DND</b> to disable global DND; --Line DND enabled, press twice <b>DND</b> ,

	-or press <b>MENU</b> button > “Function setting” > “DND” >(select line) “Disable”
--	---

### 3.5.13 3-way Conference

You can enable a three-party conference, during the conversation three phone parties can communicate with every party.

If you want to...	Then...
Invite the transfer recipient into a conference in a transferring	--1) When the transfer recipient answer the call, press <b>CONFERENCE</b> button or "CONF" on your phone; --2) Then the held one, transfer recipient and you will be into a conference, and the LCD will display <span style="border: 1px solid black; padding: 2px;">conferenc 0:0:10</span> status.
Invite the third party into a conference in a active call	--1) Press " <b>CONFERENCE</b> " button or "CONF" in an active call; --2) Enter the third party number; --3) After connected the third party, press " <b>CONFERENCE</b> " button or "CONF" again
establish a conference with held line	--1) when one phone line is holding on and the other line is busy; --2) Press " <b>CONFERENCE</b> " button, -or Press "CONF" Soft key --3) Press the held line's programmable button, the 3-way Conference is enable.

### 3.5.14 Voice Mail

You can set Voice Mail function in Menu> Message.

Voice Mail	--1) Dial the voice mail number, e.g *97 --2) Enter the User Password --3) It will login into the voice mail server. You need to follow the IVR to do it.
------------	---



## 3.6 Advanced Settings

### 3.6.1 Using the phone book

#### Enterprise Phone Book

Search the Contacts from Enterprise Phone Book	--1) Press DIR in the idle status, -or press " <b>MENU</b> " button > "Phone book">"Enterprise Phone Book", --2) Select "Enterprise Phone Book", press " <b>OK</b> " button; --3) Press "Find" and input the name who you want to search.
Call the Contact from Enterprise Phone Book	--1) Press "DIR" in the idle, -or press " <b>MENU</b> " button > "Phone book">"Enterprise Phone Book", --2) Select "Enterprise Phone Book", press " <b>OK</b> " button; --3) Press "Find" and input the name who you want to search. --4) When you search the person, you can dial it.

#### Personal Phone Book

Add Contacts	--1) Press Phone Book, -or press " <b>MENU</b> " button > "Phone book">"Personal phone book">"View All", -or press " <b>OK</b> " button > "Phone book">"Personal phone book">"View All"; --2) Select "Add contact", press " <b>OK</b> " button; --3) Use the navigation keys to select content, press " <b>OK</b> " button to set and modify: -Name: set the name of contact,
--------------	--

	<p>-Office Number: Setting the contact Office Number</p> <p>-Mobile Phone Number: Setting the contact Mobile Phone Number</p> <p>-Others Number: Setting the contact Others Number</p> <p>-SIP Account: Setting the contact call SIP account</p> <p>-Group: the contacts be divided into different user's groups</p> <p>--4) Press "<b>Save</b>" soft key to complete</p>
Add group	<p>--1) Press "DIR" soft key,</p> <p>-or press "<b>MENU</b>" button &gt; "Phone book"&gt;"Personal phone book&gt;View All",</p> <p>-or press "<b>OK</b>" button &gt; "Phone book"&gt;"Personal phone book&gt;View All";</p> <p>--2) Select the "add group" then press <b>OK</b> button;</p> <p>--3) Use the navigation keys to select content, press <b>OK</b> button to set and modify:</p> <p>-Group name: name of the group</p> <p>--4) Press "<b>Save</b>" soft key to complete</p>
Modify group	<p>--1) Press "DIR" soft key,</p> <p>-or press "<b>MENU</b>" button &gt; "Phone book"&gt;"Personal phone book&gt;View All",</p> <p>-or press "<b>OK</b>" button &gt; "Phone book"&gt;"Personal phone book&gt;View All";</p> <p>--2) Select the "Modify group" then press "<b>OK</b>" button ;</p> <p>--3) Select the group you want to modify, press the "<b>OK</b>" button to set and modify, press "<b>Save</b>" to save the change</p>
Delete group	<p>--1) Press "DIR" soft key,</p> <p>-or press "<b>MENU</b>" button &gt; "Phone book"&gt;"Personal phone book&gt;View All",</p> <p>-or press "<b>OK</b>" button &gt; "Phone book"&gt;"Personal phone</p>

	<p>book&gt;View All”;</p> <p>--2) Select the “Delete group” button;</p> <p>--3) Select a group you want to delete, press <b>OK</b> button</p>
--	---

## LDAP

Search the Contacts from LDAP	<p>--1) Press "DIR" in the idle, -or press "<b>MENU</b>" button &gt; “Phone book”&gt;“LDAP”,</p> <p>--2) Select “LDAP”, press "<b>OK</b>" button;</p> <p>--3) Press "Find" and input the name or number who you want to find search from the LDAP server.</p>
Call the Contact from LDAP	<p>--1) Press "DIR" in the idle, -or press "<b>MENU</b>" button &gt; “Phone book”&gt;“LDAP”,</p> <p>--2) Select “LDAP”, press "<b>OK</b>" button;</p> <p>--3) Press "Find" and input the name or number who you want to find from the LDAP server.</p> <p>--4) When you search the person, you can dial it.</p>

## Black List

Add the Contacts	<p>--1) Press "DIR" in the idle, -or press "<b>MENU</b>" button &gt; “Phone book”&gt;“Black List”,</p> <p>--2) Select “Black List”, press "<b>OK</b>" button;</p> <p>--3) Press "Add" and input the name\office number\mobile number\other number\SIP account who what you want to add into the Black List.</p>
View the Contact from Black List	<p>--1) Press "DIR" in the idle, -or press "<b>MENU</b>" or "<b>OK</b>" button &gt; “Phone book”&gt;“Black List”,</p>

	<p>--2) Select "Black List", press "OK" button;</p> <p>--3) Press "RUN" to view someone who what you want to find.</p> <p>--4)If you want to move or change it, you can follow the RUN to do.</p>
--	---

### 3.6.2 Using Call Logs

Your phone maintains records of your missed, placed, and received calls.

View call logs	<p>--1) Press "MENU" or "LOG" button &gt; "All Call" &gt; "Missed Calls", "Received Calls", or "Dialed numbers"</p> <p>--2) Use the navigation keys to view the call record information.</p>
Delete/Save Call Logs	<p>--1) Login in to the Call Logs</p> <p>--2) Use the navigation keys to view the call record or select DEL key.</p> <p>--3) Use the navigation keys to view the call record or select Save key.</p>

### 3.6.3 Peer-to-Peer

When all of the phone accounts were disable or not register. it will be show this mode in the idle. It can use by when the new workstation isn't have SIP server.

Peer-to-Peer	Disable all of accounts or not register.
Make Call with Peer-to-Peer	<p>--1 ) Press MENU button&gt; System Setting&gt; Advanced Setting&gt; SIP Account;</p> <p>--2 ) Disable all of accounts or un-register;</p> <p>--3 ) Turn back the phone idle, you can call someone use IP address.</p>

### 3.7 Keypad Setting

ULTRATIVE series IP Phone can through two ways configuration it, one is setting in MENU, and another is setting in website. Here just description in MENU.

NOTES: When you want to input the IP address like ".", it was replaced by the "\*".

### 3.7.1 Language Setting

UTT-205 IP Phone support Multi-Language setting, as below is an example.

Switch the Language between Chinese and English	<p>--1) Press MENU button&gt; System Setting&gt; Phone Setting&gt; Language</p> <p>--2) Here you can select English\French\Italian\Polish\Protuguese\Runssian\Spanish\Turkish\Chinese</p> <p>--3) After you finish select, press Save to make it work.</p>
---	--

### 3.7.2 Message

UTT-205 have Message feature. It will display in the LCD when it has a New Message.

Create a Message	<p>--1) Press MENU button;</p> <p>--2) Select "Messaging"</p> <p>--3) Voice Message: Setting the Voice Message code in here. Text Message: Write down the Text Message in here.</p> <p>--4) Select Text Message&gt; New Message.</p> <p>--5) Input the receiver and write down message body, and then press send to finish.</p>
Message Inbox	<p>--1) Select Message Inbox.</p> <p>--2) Select which one you want to check.</p> <p>--3) You can press Enter to read or press Del to delete.</p>

### 3.7.3 Time & Date

SNTP	<p>--1) Press MENU button;</p> <p>--2) Press MENU button&gt; System Setting&gt; Phone Setting&gt; Time &amp; Date&gt; Time and Date setting&gt; SNTP</p> <p>--3) SNTP</p> <ul style="list-style-type: none"> <li>-Time Zone: Setting the time zone</li> <li>-NTP Server 1: NTP server address 1</li> <li>-NTP Server 2: NTP server address 2</li> <li>-DayLight: Enable/Disable Day Light</li> </ul>
SIP Server	<p>--1) Press MENU button;</p> <p>--2) Press MENU button&gt; System Setting&gt; Phone Setting&gt; Time &amp; Date&gt; Time and Date setting&gt;SIP Server</p> <p>--3) Press Save to make it work</p>

Manual Setting	<p>Press MENU button;</p> <p>--2) Press MENU button&gt; System Setting&gt; Phone Setting&gt; Time &amp; Date&gt; Time and Date setting&gt; Manual Setting</p> <p>--3) Manual Setting</p> <p>- Manual Setting: Year\Month\Days\Hours\Minutes\Seconds</p>
Time Display Format	<p>--1) Press MENU button;</p> <p>--2) Press MENU button&gt; System Setting&gt; Phone Setting&gt; Time &amp; Date&gt; Time Display Format</p> <p>--3) Time Mode: 24hour\12hour</p> <p>Date mode:</p> <p>DDMMWWW\MMDDDWW\WWDDMMM\DDMMMYY\YYYYMMDD\DDMMYY\MMDDYY\DDMMMYYYY\WWDDMMM etc.</p>

### 3.7.4 Ring Tone and Volume Setting

Ring Type	<p>--1) Press MENU button;</p> <p>--2) Press MENU button&gt; System Setting&gt; Phone Setting&gt;Ring Type</p> <p>--3) Select the ring type from 1 to 8 or custom ring, and then press Save to make it work.</p>
Volume Setting	<p>--1) Press MENU button;</p> <p>--2) Press MENU button&gt; System Setting&gt; Phone Setting&gt; Volume Setting</p> <p>--3) Volume Setting: Handset\Speaker\Headset\Ring volume</p> <p>--4) Press Enter to adjust the volume and press Save to make it work</p>

NOTES: For the Custom Ring Type you need to upload it from website.

### 3.7.5 Searching Phone Book

Accurate Search	<p>--1) Press <b>MENU</b> button &gt; "Function Setting", you can select " Accurate Search "</p> <p>--2) Then press Enable/Disable and Save.</p> <p>--3) When you back to idle, you can use the digital keypad to search the contact.</p>
T9 Search	<p>--1) Press <b>MENU</b> button &gt; "Function Setting", you can select " T9 search"</p> <p>--2) Then press Enable/Disable and Save.</p> <p>--3) When you back to idle, you can use the digital keypad to search the contact.</p>

NOTES: The Search Phone Book setting default is Accurate Search.

### 3.7.6 Cannot Set the Features with Keypad

As below features are cannot setting with the keypad:

- 1) Dial Plan.
- 2) Custom Ring Type
- 3) SNTP Server and Time & Date
- 4) Update the Firmware or Backup.

## 4. WEB User Interface

In addition to the phone user interface, you can also customize your phone via web user interface. In order to access the web user interface, you need to know the IP address of your new phone. To obtain the IP address, press the C key on the phone. Enter the IP address (e.g. HTTP://192.168.0.10 or 192.168.0.10) in the address bar of web browser on your PC. The default user name is root (case-sensitive) and the password is root (case-sensitive).

### Main Interface-Phone Status

Here you can see as below information: System Run Time, Register Status, Network Status, System Information,

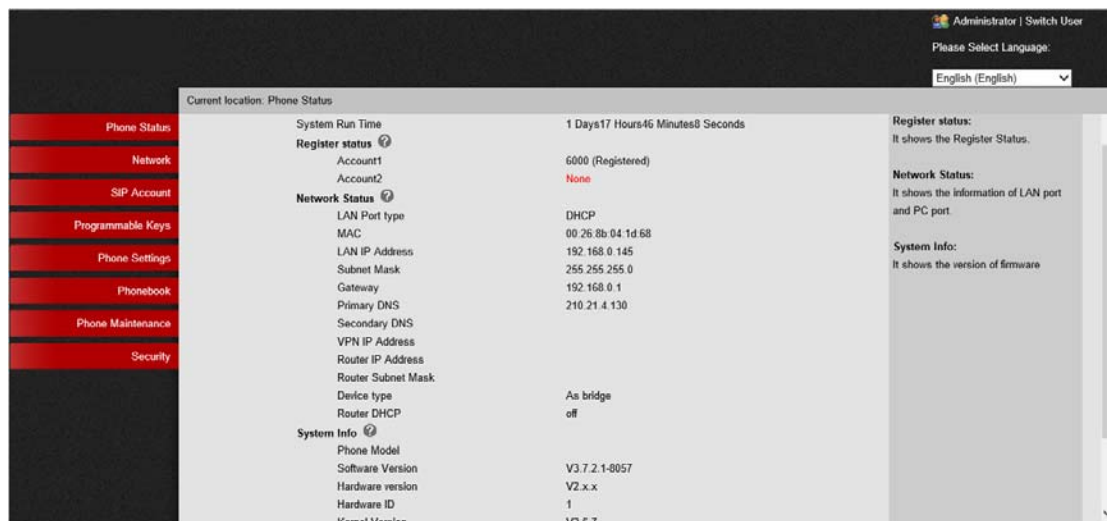

ITEM	DESCRIPTION
System Run Time	The phone system normal running time.

Register Status	The status with Account 1~3.
Network Status	The status with LAN, MAC, LAN IP, Net mask, Gateway, Primary DNS, Secondary DNS, VPN IP, PC IP, PC Net mask, Device Type, DHCP Server.
System Information	The status with Phone Model, Software Version, Hardware Version, Hardware ID, Kernel Version, Auto-Provision Server URL, TFTP Server IP.

## 4.1 Net Work

### 4.1.1 LAN Port

#### Basic

Basic >>

DHCP ?

    Hostname(Option 12)

    Manufacturer(Option 60)

Static IP ?

    IP Address

    Netmask

    Gateway

PPPoE ?

    Username

    Password

    MTU  Default: 1500

**DNS Settings**

    DNS  Automatic  Manual DNS

    Primary DNS

    Secondary DNS

ITEM	DESCRIPTION
Network Connection Mode	Network Connection Mode has DHCP, Static IP, PPPoE.
DNS Settings	Select the DNS mode that you want.



## Advanced

**Port Management Settings**

HTTP Port

Telnet Port

**Socket5 Proxy Server**

Socket5 Proxy Server  off  on

Server IP  \*

Port  \*

Anonymous Login

Username

Password

**Paging Setting**

Paging 1  off  on

Group IP  Port:

Paging 2  off  on

Group IP  Port:

Paging 3  off  on

Group IP  Port:

Paging 4  off  on

Group IP  Port:

Paging 5  off  on

Group IP  Port:

**Please Note:** Changing the default HTTP Port (80) will require using the new port number to access the IP phone web interface. Please note that changes require a reboot. Use the following format when not using the default HTTP (<http://ip address:portnumber>).

ITEM	DESCRIPTION
<b>Port Management Settings</b>	
HTTP Port	The default web port is 80,if you want to change it(for example change it to88), You must input IP and Web port to login the web page(for example <a href="http://192.168.0.200:88">HTTP://192.168.0.200:88</a> ). It will take effect on next reboot.
Telnet Port	The default Telnet port is 23,if you want to change it(for example change it to 2003). You must input IP and Telnet port to login the manage page (for example telnet 192.168.0.200:2003).It will take effect on next reboot.

Socket5 Proxy Server	
Socket5 Proxy Server	Enable/Disable Socket5 Proxy Server.
Server IP	Socket5 Proxy Server IP address.
Port	Socket5 Proxy Server port, default is 1080.
Anonymous Login	Enable/Disable Socket5 Proxy Server login username.
<b>Paging Setting(NOTE: This feature priority is followed the serial number, In other words, "paging 1" is the highest priority)</b>	
Paging1	Enable/Disable Paging feature.
Group IP and Port	Group IP and Port with Paging.

## 4.1.2 PC Port

Normally choose Bridge, if you choose Router ,you need to input router IP address ,net mask.

**Bridge** ?  
 **Router** ?  
 IP Address  \*  
 Netmask  \*  
 DHCP Server  off  on  
 Start IP   
 End IP

### Bridge

Normally, you should choose “bridge” feature, it means that pc port and LAN port will share the same network.

### Router

Router feature is for the phone PC Port. You must input IP address (it’s equivalent to a gateway) and Net mask. If you want to use DHCP function, please turn it on, input start IP and end IP.

## 4.1.3 Advanced

### VPN Setting

Enable VPN	<input type="checkbox"/>
VPN Type	L2TP SSL_VPN
L2TP	
VPN Server Addr	<input type="text"/>
VPN User Name	<input type="text"/>
VPN Password	<input type="text"/>

When using VPN Setting option, you can set several parameters as follow:

VLAN Setting	
Enable VPN	You can enable/disable VPN for phone and pc.
VPN Type:	Choose the appropriate type of VPN.
VPN Server Addr	VPN server's IP.
VPN User Name	VPN user's name
VPN Password	A password be used for authentication

### VLAN Setting

Enable Vlan:	<input type="checkbox"/>		
<b>LAN Port</b>		<b>PC Port</b>	
VID:	<input type="text" value="0"/> (0~4094)	VID:	<input type="text" value="0"/> (0~4094)
Priority:	<input type="text" value="0"/> (0~7)	Priority:	<input type="text" value="0"/> (0~7)

When using VLAN Setting option, you can set several parameters as follow:

VLAN Setting	
Enable VLAN	You can enable/disable vlan for phone and pc
VID [LAN/PC Port]	The vlan ID you want the phone or pc to join

# 5 SIP Account

## 5.1 Basic

Enable	<input checked="" type="checkbox"/>
Account Mode	VOIP
Amount Of Line Account Used	1 ( Default: 2)
Display Name	<input type="text"/>
Username	5207 *
Authenticate Name	5207
Password	•••• *
Label	<input type="text"/>
SIP Server	192.168.0.7
Secondary server	<input type="text"/>
OutboundProxy Server	<input type="text"/>
Secondary OutboundProxy Server	<input type="text"/>
Polling Interval Time Of Registration	32 s Default Value: 32s, Range: 20s--60s
NAT Traversal	Disable
STUN Server	<input type="text"/>
BLA	<input checked="" type="radio"/> off <input type="radio"/> on
BLA Number	<input type="text"/>
Subscribe Period	1800 Default: 1800s, Min: 120s
Register Expire Time	3600 Default: 3600s, Min: 40s
Auto Answer	<input checked="" type="radio"/> off <input type="radio"/> on
SIP Transport	<input checked="" type="radio"/> UDP <input type="radio"/> TCP <input type="radio"/> TLS
Ring Type	None

Choose one Account, you will find the following parameters:

ITEM	DECSRIPTION
Enable	You can choose on/off to enable/disable the line.
Account Mode	You can choose VOIP/PSTN, but this model nonsupport PSTN, If you need, Please contact us to buy another model that can supports PSTN.
Amount Of Line Account Used	The line key of account used, default is 2
Display Name	It is showed as Caller ID when making a phone call

Username	It is a username provided by SIP Server
Authenticate Name	It is authenticated ID for authentication
Password	It is a password provided by SIP Server
Label	Label with this account.
SIP Server	Server for registration, provided by administrator
Secondary server	When the main server can't work, it also can register in this secondary server.
Outbound Proxy Server	Put into the address with the outbound proxy server.
Secondary Outbound Proxy Server	When the main out bound server can't work, it also can use this secondary server.
Poling Interval Time Of Registration	Poling Interval Time Of Registration, default is 32 s.
NAT Traversal	Defines the STUN server will be active or not
STUN Server	Session traversal utilities for NAT.
BLA	Share with the line.
BLA Number	BLA Number
Subscribe Period	Subscribe expire time.
Register Expire Time	IP phone automatically registered every time
SIP Transport	There are UDP/TCP/TLS three options
Ring Type	Select this account ringing type.

## 5.2 Call

Do Not Disturb	<input checked="" type="radio"/> off <input type="radio"/> on
Anonymous Call	<input checked="" type="radio"/> off <input type="radio"/> on <input style="font-size: 1em; vertical-align: middle;" type="button" value="?"/>
Anonymous Call Rejection	<input checked="" type="radio"/> off <input type="radio"/> on <input style="font-size: 1em; vertical-align: middle;" type="button" value="?"/>
Use Session Timer	<input checked="" type="radio"/> off <input type="radio"/> on
Session Timer	<input type="text" value="300"/> (min:150s)
Call Method	<input checked="" type="radio"/> SIP <input type="radio"/> TEL
DNS-SRV	<input checked="" type="radio"/> off <input type="radio"/> on
Allow-events	<input checked="" type="radio"/> off <input type="radio"/> on
Registered NAT	<input type="radio"/> off <input checked="" type="radio"/> on
UDP Keep-alive Message	<input checked="" type="radio"/> off <input type="radio"/> on
UDP Keep-alive Interval	<input type="text" value="30"/> (15-60s)

ITEM	DECSRIPTION
<b>Call</b>	
Do Not Disturb	Enable/Disable Do Not Disturb
Anonymous Call	Enable/Disable anonymous call.
Anonymous Call Rejection	Enable/Disable anonymous call rejection.
Use Session Timer	Enable/Disable refresh session function. The device will send an Invite packet to refresh the session during a call if it enable.
Session Timer	The refresh session time interval.
Call Method	This method include SIP and TEL.
DNS-SRV	Enable/Disable DNS-SRV.
Allow-events	Enable/Disable Allow-events.
Registered NAT	Enable/Disable Registered to NAT
UDP Keep-alive Message	The phone periodically sends a UDP packet to keep the port active and to avoid the server to shut down the port
UDP Keep-alive Interval	Default is 30 second.

## 5.3 Security

SIP Encryption	<input checked="" type="radio"/> off <input type="radio"/> on ?
RTP Encryption	<input checked="" type="radio"/> off <input type="radio"/> on ?
Encryption Algorithm	RC4 ▼
Encryption Key	<input type="text"/>

ITEM	DECSRIPTION
<b>Security</b>	
SIP Encryption	Enable/Disable SIP encryption.
RTP Encryption	Enable/Disable RTP encryption.
Encryption Algorithm	The encryption algorithm at this time we only have RC4.
Encryption Key	The key with encryption.

# 6 Phone Setting

## 6.1 Basic

BackLight	<input type="radio"/> off <input type="radio"/> Always On <input checked="" type="radio"/> timer <input type="text" value="60"/> s (Min:1, Max:255) ?
Keyboard Lock	<input type="text" value="Disabled"/> ?
Hot Line Function	<input checked="" type="radio"/> off <input type="radio"/> Delay <input type="text" value="5"/> s (0-30)
Hot Number	<input type="text"/> ?
Auto Answer	<input checked="" type="radio"/> off <input type="radio"/> on <input type="radio"/> Turn On But Filter This Group: <input type="text" value="NONE"/> ?
Auto Answer Mode	<input checked="" type="radio"/> Hands Free <input type="radio"/> Handle <input type="radio"/> Headset
Call Waiting	<input type="radio"/> off <input checked="" type="radio"/> on ?
Call Waiting Tone	<input type="radio"/> off <input checked="" type="radio"/> Play on currently active device Frequency: <input type="text" value="10"/> s (5-60) ?
DTMF	<input checked="" type="radio"/> RFC 2833 <input type="radio"/> Inband <input type="radio"/> SIP Info <input type="radio"/> Auto ?
Fuzzy Search	<input checked="" type="radio"/> off <input type="radio"/> on
Phonebook Search	<input checked="" type="radio"/> Accurate Search <input type="radio"/> T9
Call List Save	<input type="radio"/> off <input checked="" type="radio"/> on
Network Packet Mirroring	<input type="text" value="Off"/> ?

ITEM	DECSRIPTION
<b>Basic</b>	
Back Light	The backlight of the phone LCD.
Keyboard Lock	Enable/Disable keyboard lock, you can lock: MENU Key, FUNCTION Key., ALL Keys, LOCK all keys but auto Answer.
Hot Line function	When you pick up the handset, it will dial out with the hot number.
Hot Number	Input the number what you want to.
Auto Answer	Auto-answer the coming call, it also can filter a contact group.
Auto Answer Mode	Auto-answer the coming call, it also can filter a device to answer.
Call Waiting	When there's coming a call or the phone is talking, the second call will be in the queue.
Call Waiting Tone	Select the frequency with the tone when call waiting.
DTMF	The DTMF transmitted mode, include RFC2833,Inband,SIP Info, Auto
Fuzzy Search	Fuzzy search someone with the phone book in the idle.
Phone Book Search	Enable/Disable the phone book search feature with accurate or T9 mode.
Call List Save	You can choose to save the call list into the phone or not.
Network Packet Mirroring	When select on, then you can capture the phone's packet use notebook which connect to pc port of the phone

## 6.1.1 Time Settings

Set Time Mode  SNTP  SIP Server  PSTN  Manual

SNTP Server sparky.services.adelaide.edu.au

sparky.services.adelaide.edu.au  List

sparky.services.adelaide.edu.au Manual

Update Interval  Seconds

(seconds)

Daylight Savings Time  always off  always on  Auto

Mode

Time Format  24 Hour  12 Hour

Date Format

Time Zone-GMT

Manual Setting  Year  Month  Days

Hours  Minutes  Seconds

ITEM	DESCRIPTION
<b>Time Settings</b>	
Set Time Mode	Include SNTP/SIP Server/PSTN/Manual
SNTP Server	You can select in the list or input owner server address.
Update Interval	The update interval with SNTP.
Day Light Saving Time	Enable/disable the DST for the phone
Time Format	You can use 24 hour time format or 12 hour time format
Date Format	You can choose the appropriate time format.
Time Zone-GMT	You can select different time zone for the phone
Manual Setting	Setting time manually.



## 6.1.2 Call

Pickup Function	<input type="radio"/> off <input checked="" type="radio"/> on
Pickup Code	<input type="text" value="123"/>
Message	<input type="text" value="*97"/>
Booking Voicemail	<input type="text" value="No"/> ▾
Play Voicemail Tone	<input checked="" type="radio"/> off <input type="radio"/> on
Miss Call Display	<input type="radio"/> off <input checked="" type="radio"/> on
DND Softkey	<input type="radio"/> off <input checked="" type="radio"/> on
Play Hangup Tone	<input type="radio"/> off <input checked="" type="radio"/> on
Transfer Code	<input checked="" type="radio"/> off <input type="radio"/> on Number: <input type="text"/>
Conference Exit Result	<input checked="" type="radio"/> Disconnect All <input type="radio"/> Others Remain Connected
Return code when refuse	<input type="text" value="603(Decline)"/> ▾ ?
Return code when DND	<input type="text" value="603(Decline)"/> ▾ ?
Flash hook time(<800ms)	<input type="text" value="500"/>
Called No AnswerTime	<input type="text" value="70"/> s (Min:20, Max:99)
Pound Send Method	<input checked="" type="radio"/> # <input type="radio"/> %23
RFC 2833 PayLoad	<input type="text" value="101"/>
P-Asserted-Identity	<input type="radio"/> off <input checked="" type="radio"/> on
SIP Session Timer(seconds) T1	<input type="text" value="0.5"/> ?
SIP Session Timer(seconds) T2	<input type="text" value="4"/> ?
SIP Session Timer(seconds) T4	<input type="text" value="5"/> ?
Local SIP port	<input type="text" value="5060"/> (Default: 5060)
RTP Port Range	<input type="text" value="10000"/> -- <input type="text" value="10128"/>
Affiliated Port	<input type="radio"/> off <input checked="" type="radio"/> on
Headset Mode	<input checked="" type="radio"/> Normal <input type="radio"/> Seat Mode
Ring Type On Seat Mode	<input checked="" type="radio"/> Headset <input type="radio"/> Speaker

ITEM	DESCRIPTION
<b>Call</b>	
Pickup Function	When you are not in the position, others can help you to answer.
Pickup Code	Fill in server's pickup code.
Message	The code with voice message.
Booking Voice Mail	Open this feature, the phone light(Message) will be bright when it get message.
Play Voice Mail Tone	Open this feature, it will be ringing when it get message.
Miss Call Display	Turn on or off the display with Miss call in the phone LCD.

DND Soft key	Enable/Disable the DND feature.
Play Hang-up Tone	The tone with hang up in busy.
Transfer Code	The code with transfer.
Conference Exit Result	Conference originator hang up the phone, hang up two ways of it.
Return Code When Refuse	Select the code feedback to the server when you reject the call.
Return Code When DND	Select the code feedback to the server when you open DND function.
Flash Hook Time(<800ms)	The time with the flash hook.
Called No Answer Time	When it has coming call and enable this feature, the caller will be request time out in the stipulated time.
Pound Send Method	When you to use the code, such as: #28#123 or %23123, you need to set this feature.
RFC 2833 Play Load	Default is 101, RTP Payload for DTMF Digits, Telephony Tones and Telephony Signals
P-Asserted-Identity	Enable/Disable the P-Asserted-Identity feature.
SIP Session Timer T1	The SIP Session Timer setting.
SIP Session Timer T2	The SIP Session Timer setting.
SIP Session Timer T4	The SIP Session Timer setting.
Local SIP Port	The port range setting with SIP, default is 5060.
RTP Port Range	The port range with RTP
Affiliated Port	Enable/Disable the affiliated port feature.
Headset Mode	Select headset mode with normal or seat.
Ring Type On Seat Mode	Select ring type mode with headset or speaker.

### 6.1.3 VoIP Call Forward

Always  off  on Number:  ?  
 If Busy  off  on Number:  ?  
 If No Answer  off  on Number:  ?  
 Ring Frequency  Seconds (Default: 15s, Max: 15s)

ITEM	DESCRIPTION
Always	All ways transfer the call to others.
If Busy	If the phone was busy working, the call will be transfer to others.
If No Answer	If the phone was no answer, the call will be transfer to others.
Ring Frequency	The ring frequency with the VOIP Call Forward.

## 6.1.4 QoS

SIP QoS	<input type="text" value="26"/>	(0-63)
Voice QoS	<input type="text" value="46"/>	(0-63)

ITEM	DESCRIPTION
SIP QoS	The range is 0~63,default is 26
Voice QoS	The range is 0~63,default is 46

## 6.2 Advanced

### 6.2 .0 Audio

#### 6.2.1 Basic

**Tone** 

Select Country  

Ring Volume(0~9)

**Output Volume(1~9)**

Handset Volume

SpeakerPhone Volume

Headset volume

**Input Volume(1~7)**

Handset Mic Volume

SpeakerPhone Mic Volume

Headset Mic Volume

ITEM	DESCRIPTION
<b>Basic</b>	
Select Country	Select the country dial tone. Default is United States.
Ring Volume	The ring volume default is Lv3, the range is 0~9.
Handset Volume	The handset volume default is Lv5, the range is 1~9.
Speaker Phone Volume	The speaker volume default is Lv5, the range is 1~9.

Headset Volume	The headset volume default is Lv3, the range is 1~9.
Handset MIC Volume	The handset MIC volume default is Lv3, the range is 1~7.
Speaker Phone MIC Volume	The speaker MIC volume default is Lv3, the range is 1~7
Headset MIC Volume	The headset MIC volume default is Lv3, the range is 1~7

## 6.2.2 Advanced

**Ring** ?

Ring Type

Uploading Ring Tone

(Please upload a ring tone with G711A audio coding, Maximum 10 rings and the total sizes must less than 150k.)

**Audio Codecs** ?

**Jitter Buffer** ?

Type  Adaptive  Fixed

Min Delay

Max Delay

Normal Delay

**Other**

Payload Length  ms

High Rate of G723.1

VAD  ?

Echo Suppression Mode

SideTone

ITEM	DESCRIPTION
<b>Ring</b>	
Ring Type	Select the ring type. Default is Ring 1.
Uploading Ring Tone	Please upload a ring tone with G711A audio coding, Maximum 10 rings and the total sizes must less than 150k.
<b>Audio Codec</b>	Use the navigation keys to highlight the desired one in the Enabled/Disable Codes list, and press the <input type="button" value="&gt;&gt;"/> / <input type="button" value="&lt;&lt;"/> to move to the other list.
<b>Jitter Buffer</b>	

Type	The type of Jitter Buffer is Adaptive or Fixed, default is adaptive.
Min Delay	The min delay range setting , default is 60.
Max Delay	The max delay range setting , default is 150.
Normal Delay	The normal delay range setting , default is 120.
<b>Other</b>	
Play Load Length	The play load length setting, default is 30ms.
High Rate Of G723.1	Enable/Disable High Rate of G723.1 feature.
VAD	Enable/Disable VAD feature.
Echo Suppression Mode	Enable/Disable Echo Suppression Mode feature.
Side Tone	Enable/Disable Side Tone feature.

## 6.3 Line Keys

	Mode	Account	Name	Number
Key1:	Line	Account1		
Key2:	Line	Account1		
Key3:	Line	Account1		

line keys >>

	Mode	Account	Name	Number
Key1:	Line	Account1		
Key2:	Speed Dial	Account1		
Key3:	Speed Dial Prefix	Account1		
	DTMF			
	BLF			
	Paging			
	Call Park			
	Intercom			
	BLA			

Function Keys >>

ITEMS	DESCRIBES
Line	The default value.
Speed Dial	You can use this key feature to speed up dialing the numbers often used or hard to remember.
Speed Dial Prefix	You can use this key feature to speed up dial a call with a specified prefix number.
DTMF	You can use this key feature to send the specification of arbitrary key sequences via DTMF.
BLF	You can use the BLF feature to monitor a specific user for status changes on the phone.
Paging	You can use multicast paging to quickly and easily forward time sensitive announcements out to people within the multicast group.
Call Park	You can use call park feature to place a call on hold, and then retrieve the call

	from another phone in the system (for example, a phone in another office or conference room).
Intercom	You can press the configured intercom key to automatically connect with a remote extension for outgoing intercom calls, and the remote extension will automatically answer the incoming intercom calls
BLA	This feature such as the BLF.

NOTE: ONLY WHEN YOU CHOOSE "SPEED DIAL", THE RIGHT OF "NAME","NUMBER" WILL TAKE EFFECT.

## 6.4 Function Keys

Function Keys: If you do not like the default setting with the function keys feature. You can change to whatever you like.

**NOTE: IF THE PHONE WITHOUT THE KEY, YOU CAN IGNORE IT.**

	Operation	Account	Name	Number
Up:	Contacts	Account1		
Down:	Redial	Account1		
Left:	Default	Account1		
Right:	Default	Account1		
OK:	Redial	Account1		
Conference:	DND	Account1		
Redial:	Contacts	Account1		
Transfer:	Enterprise Phonebook	Account1		
Hold:	LDAP	Account1		
Service:	Dir	Account1		
Directories:	Speed Dial	Account1		
Menu:	Call List	Account1		
Mute:	Missed Calls	Account1		
Message:	Received Calls	Account1		
	Dialed Calls	Account1		
	Menu	Account1		
	SMS	Account1		
	New SMS	Account1		
	Call Forward	Account1		
	View Status	Account1		
	Call Forward	Account1		

## 6.5 Soft Key

Soft Keys: Soft key is the key with below display in the LCD. You can change it for your mind to the other features in many all kinds of status. As below example, when you dialing with someone, the LCD display soft key is Send \Del \Empty\End, Empty means nothing in it.

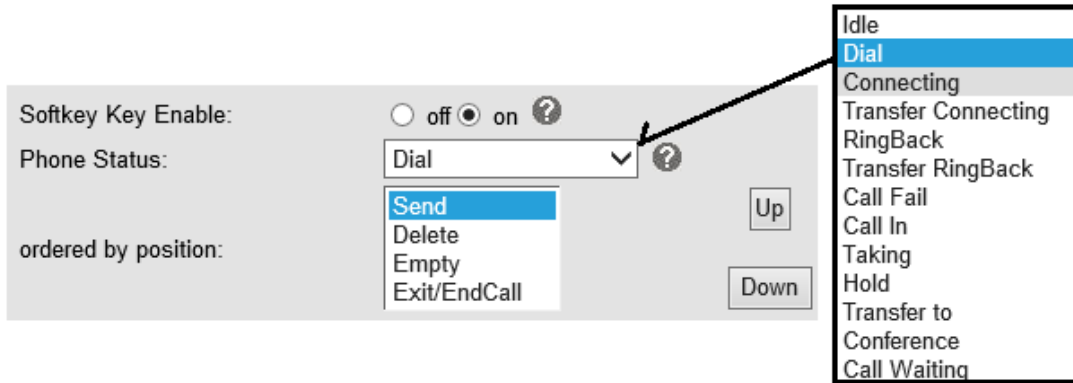

## 6.6 Dial Plan

If you want to setup a dial plan, you can click "Dial Plan"

Send Key  \*  #  
 Dial Length   
 No Dial Timeout

ID	Operation	Prefix	IP Address	Description
<input type="button" value="Add Rule"/> <input type="button" value="Delete All Rule"/>				

ITEM	DESCRIPTION
Send Key	Select the default send key mode you want to use.
Dial Length	Enable this feature will limit the dial length. Default is 25.
No Dial Timeout	Setting the range with no dial timeout, default is 5.
Dial Rule	Select the Add Rule button to add dial rule, Please see as below detail.

ID   Description   
IP  Port(Default 5060)   
Prefix   
Called Insert Number   Called Delete Number    
Position  Position   
Number  Length

(Note: When you want to add code and delete at the same time, you can add code first, after that base on the number you add, decide the position and length of the delete code.)

ITEM	DECSRIPTION
ID	Dial Plan ID
IP	The ip of a phone which you want to call
Description	Description with this dial rule.
Port	Setting the Port with this dial rule, default is 5060.
Prefix	The number which you need to press actually if you want to call the phone
Called Insert Number	There have two option, Enable or Disable.
Position	Which position you want insert the number
Number	Which number you want to insert
Called Delete Number	There have two option, Enable or Disable.

**NOTES: If you want to know more detail about Dial Rule, Please find it in the official website to download the specific document. [HTTP://www.ULTRATIVE.com](http://www.ULTRATIVE.com).**

## 6.7 IP Strategy

You can use IP Strategy feature to make a list which can be set to only allow the incoming call on the list.

e.g. As following picture you can see it has 192.168.0.248 in the list. When you open this feature. It means you just allow come from this IP address meeting

IP Strategy <input checked="" type="radio"/> off <input type="radio"/> on				
ID	Operation	IP Address	Description	Account

## 7 Phone Book

The phone book including Group, Contact, LDAP and Ban list, please review the following for more details:

### 7.1 Group

You can add, edit and delete group in a phone book on this web page.

ID	<input type="text" value="2"/>	Description	<input type="text" value="test2"/>
Group Name	<input type="text" value="test2"/>	Ring Type	<input type="text" value="Ring2"/>
<input type="button" value="Submit"/> <input type="button" value="Cancel"/>			





**Click the groupname you can modify or delete the member of the group**

ID	Operation	Group Name	Group Member	Description	Ring Type
1	 	test	0	test	Ring1

Attention: If you Click 'Delete Group' or 'Delete All Group',the member of group can not within a group,please click the group and delete the group.

If you want to add a Group, you just ought to click 'Add Group' .

You can edit an existed Group by click  .

You can delete an existed Group by click  , if you want to delete all Groups, you just ought to click 'Delete All Group'.

## 7.2 Contact

You can add, edit and delete contact in a phone book on this web page .

The phonebook can storage 300 contacts entry

Serial Number	<input type="text" value="1"/>		
First Name	<input type="text" value="test"/>	Last Name	<input type="text" value="test"/>
Mobile Number	<input type="text" value="1111"/>	Office Number	<input type="text" value="1111"/>
OtherNumber	<input type="text" value="1111"/>	Account	<input type="text" value="Account1"/>
Group1	<input type="text" value="test"/>	Group2	<input type="text" value="None"/>

<input type="checkbox"/>	ID	Operation	Name	Phone	Group
<input type="checkbox"/>	1	   	test test	Number1:1111 Number2:1111 Number3:1111	test

Attention:if you want to download or upload the contact,please go to the "Phone Maintenance" page

If you want to add a Contact, you just ought to click 'Add Contact' .

You can edit an existed Contact by click  .

You can delete an existed Contact by click  , if you want to delete all Contacts, you just ought to click 'Delete All Contact'.

You can edit or move this contact to Ban List after you select  .

You can download and save this contact to PC after you select  .

## 7.3 LDAP

**NOTES: If you want to know more detail about LDAP, Please find it in the office website to**

[www.ultrative.com](http://www.ultrative.com)

download the specific document. [HTTP://www.ULTRATIVE.com](http://www.ULTRATIVE.com). As below figure is an example.

e.g.

LDAP Name Filter:(sn=%s)

LDAP Number Filter:(telephoneNumber=%s)

Server Address:192.168.0.65

BASE: DC=ldap,DC=ultrative,DC=com

User Name: bb@ldap.ultrative.com

Pass Word: ultrative\_2012

LDAP Name Attributes 1:sn

LDAP Name Attributes 2:cn

LDAP Number Attributes 1:telephoneNumber

LDAP	<input checked="" type="radio"/> on <input type="radio"/> off ?
LDAP Name Filter	<input type="text" value="sn=%s"/> ?
LDAP Number Filter	<input type="text" value="telephoneNumber=%s"/> ?
Server Address	<input type="text" value="192.168.0.65"/> ?
CWMP Port	<input type="text" value="389"/> ?
Base	<input type="text" value="DC=ldap,DC=ultrative,C"/> ?
Username	<input type="text" value="bb@ldap.ultrative.com"/> ?
Password	<input type="text" value="ultrative_2012"/> ?
Max. Hits(1~32000)	<input type="text" value="50"/> ?
LDAP Name Attributes 1	<input type="text" value="sn"/> ?
LDAP Name Attributes 2	<input type="text" value="cn"/>
LDAP Name Attributes 3	<input type="text"/>
LDAP Number Attributes 1	<input type="text" value="telephoneNumber"/> ?
LDAP Number Attributes 2	<input type="text"/>
LDAP Number Attributes 3	<input type="text"/>
Protocol	<input type="radio"/> Version 2 <input checked="" type="radio"/> Version 3 ?
Search Delay(ms)(0~2000)	<input type="text" value="0"/> ?
LDAP Lookup For Incoming Call	<input checked="" type="radio"/> on <input type="radio"/> off ?
LDAP Lookup For PreDial/Dial	<input checked="" type="radio"/> on <input type="radio"/> off ?

## 7.4 Ban List

You can add, edit and delete contact in a Ban List on this web page.

Serial Number: 1 (dropdown)      Description: test3

First Name: test3      Last Name: testc



Mobile Number: 3333

Home Number: 3333

Office Number: 3333

Account: Auto (dropdown menu showing Auto, Account1, Account2, Account3)

Submit      Cancel

ID	Operation	Name	Phone	Description	Account
1	  	test3 testc	Number1:3333 Number2:3333 Number3:3333	test3	Auto

Add BanList      Delete All BanList

If you want to add a Ban List, you just ought to click 'Add Ban List'.  
 You can edit an existed Ban List by click .  
 You can delete an existed Ban List by click , if you want to delete all Ban List, you just ought to click 'Delete All Ban List'.  
 You can edit or move this contact to Contact after you select .

## 8 Phone Maintenance

### 8.1 Basic

**NOTES: Don't cut off the electricity or network cable when doing upgrade in the below ways!**

#### 8.1.1 HTTP Upgrade

You can upgrade the software, kernel and configuration etc. files by HTTP.

**HTTP Upgrade >>**

Select a File	<input type="text"/>	<input type="button" value="Browse.."/>
Software Upgrade	<input type="button" value="Upgrade"/>	
Kernel Upgrade	<input type="button" value="Kernel Upgrade"/>	
Configuration	<input type="button" value="Upload"/>	<input type="button" value="Download"/>
XML PhoneBook	<input type="button" value="Upload"/>	<input type="button" value="Download"/>
Vcard	<input type="button" value="Upload"/>	<input type="button" value="Download"/>
EXT Module	<input type="button" value="Upload"/>	<input type="button" value="Download"/>
Log	<input type="button" value="Download"/>	
All Config File	<input type="button" value="Download"/>	

When using HTTP upgrade, you can set several parameters as follow:

HTTP Upgrade	
Select a File	Browse the software/kernel/configuration file which you need to upgrade from HTTP
Software Upgrade	Used for upgrading the software of the phone
Kernel Upgrade	Used for upgrading the kernel of the phone
Configuration	You can used upload/download to upload/download the configure file of the phone
XML Phone Book	Used for uploading/downloading the XML phonebook of the phone
Vcard	Downloading all contacts in the Vcard mode, but upload only support one by one.
EXT Module	Used for updating/backup the expansion of the phone <b>[NOTES: The mode doesn't support this feature]</b>
Log	Used for the administrator to find out or making sure the problem with this equipment.
All Config File	All Config File includes: Configuration, Extern, Log, XML Phone book, Enterprise Phone Book.

## 8.1.2 FTP Upgrade

You can upgrade the software, kernel and configure files by FTP.

**FTP Upgrade >>**

Server IP

Filename

Username

Password

Software Upgrade

Kernel Upgrade

**Note: It's no necessary to input filename when backup.**

Configuration

Phone Book

EXT Module

When using FTP upgrade, you can set several parameters as follow:

FTP Upgrade	
Server IP	The IP address of the FTP server
Filename	Downloading from FTP server
Username	Providing by FTP server
Password	Providing by FTP server
Software Upgrade	Used for upgrading the software of the phone
Kernel Upgrade	Used for upgrading the kernel of the phone
Configuration	Used for updating/backup to update/backup the configure file of the phone
Phone Book	Used for updating/backup to update/backup the phonebook of the phone
EXT Module	Used for updating/backup the expansion of the phone [NOTES: The mode doesn't support this feature]

**NOTES: It's not necessary to input filename when doing backup Configuration, Phone Book, EXT Module.**

### 8.1.3 TFTP Upgrade

You can upgrade the software, kernel and configure files by TFTP.

**TFTP Upgrade >>**

Server IP

Filename

Software Upgrade

Kernel Upgrade

**Note: It's no necessary to input filename when backup.**

Configuration

Phone Book

EXT Module

When use TFTP upgrade, you can set several parameters as follow:

TFTP Upgrade	
Server IP	The IP address of the TFTP server
Filename	Downloading from FTP server
Software Upgrade	Used for upgrading the software of the phone
Kernel Upgrade	Used for upgrading the kernel of the phone
Configuration	Used for updating/backup the configure file of the phone
Phone Book	Used for updating/backup the phonebook of the phone
EXT Module	Used for updating/backup the expansion of the phone [NOTES: The mode doesn't support this feature]

**NOTES: It's not necessary to input filename when doing backup Configuration, Phone Book, EXT Module.**

## 8.1.4 Default Setting

You can load the phone to the factory default setting in default setting option.

**Default Setting >>**

**When click this button this equipment will restore to the default status**

**Pay Attention: It will take effect on next reboot.**

Press the 'Reset to Factory Setting' option, the phone will load to factory default setting on next reboot.

## 8.1.5 Reboot

You can use reboot option to reboot the phone.

Reboot >>  
**Attention: When click this button this equipment will be reboot, web service will be interred, please connect again.**

Reboot

## 8.2 Advanced

### 8.2.1 Log

This feature is use for the administrator to managing the equipment, like debugging, SIP etc,. If you need to catch a debugging Level, you need to setup on this interface.

Log >>

No Record  
 Call  
 SIP  
 LCD

Log send to server  off  on

Log Server Address  : 514

Capture Packet

Error Level  
Warning Level  
Record Level  
Debugging Level

### 8.2.2 Auto Provision

When you open this auto provision feature, the phone will do auto provision after it detect a different software or kernel (Higher or Lower) which are putted on the TFTP,HTTP,HTTPS,FTP, server. For the detailed information about auto provision, you can find it in the official website: [HTTP://www.ULTRATIVE.com](http://www.ULTRATIVE.com)

**Auto Provision >>**

Auto Provision  on  off

Option:  ( Default :66, Min:1, Max:254)

Protocol  ▼

Software Server URL

Username

Password

Auto Download Software

Auto Download Kernel

Auto Download Config File

Auto Download Expansion

Auto Download Enterprise Phonebook

Auto Download Personal Phonebook

Booting Checked

Disable the phone while booting checking  off  on

Auto Provision Frequency  Hour (Default :7 days, Max:30 days )

Auto Provision Time  ▼

Auto Provision Next Time

AES Enable  off  on

AES Key

When using auto provision, you can set several parameters as follow:

Auto Provision	
Auto Provision	You can enable/disable auto provision by select on/off
Protocol	Used for auto provision, it includes TFTP/HTTP/FTP
Software Server URL	The server address of the auto provision
Username	Providing by provision server
Password	Providing by provision server
Auto Download Software	Used for auto download software from server
Auto Download Kernel	Used for auto download kernel from server
Auto Download Config File	Used for auto download config file from server
Auto Download Expansion	NOTES: The model doesn't support this feature.
Auto Download Enterprise Phonebook	Used for auto download Enterprise Phonebook from server
Auto Download Personal Phonebook	Used for auto download personal phonebook from server
Booting Checked	Used for checking the auto provision when phone booting
Disable the phone while booting checking	Enable/Disable the booting checking feature.
Auto Provision Frequency	Used for setting the time interval for auto provision
Auto Provision Time	Used for the specific time for auto provision
Auto Provision Next Time	Reset the Auto Provision Next Upgrading time.



AES Enable	You can enable/disable AES encrypt for auto provision
AES Key	The key of the AES
Auto Provision Now	Used for doing auto provision immediately

## 9 Password

Here you can setting the administrator or user WEB password management. Select your type. If you login as an administrator, you can modify both the user's and admin's passwords.

Administrator    User

Username	<input type="text" value="root"/>
Old Password	<input type="text"/>
New Password	<input type="text"/>
Confirm Password	<input type="text"/>

## 10 WEB Other Settings or Information - Appendix

### 10.1 WEB User

In the upper right corner of the website page, you can select the user or logout.



### 10.2 Multi-Language

In the upper right corner of the website page, you can select the language in the below list.

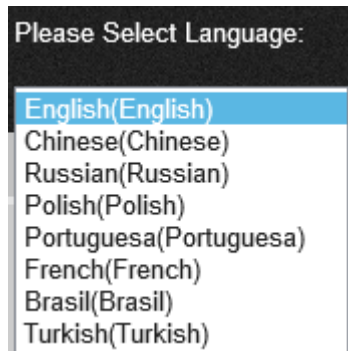

## 10.3 Note Tips

In the right middle of the website page, there is a Note tips in every function page. Hope it can help you to know something about that.

**Note**

**Register status:**  
It shows the Register Status.

**Network Status:**  
It shows the information of LAN port and PC port.

**System Info:**  
It shows the version of firmware